

Silicon PIN Diode

- Series diode for mobile communication in low loss transmit-receiver switches
- Band switch for TV-tuners
- Very low forward resistance (typ. 0.65 Ω @ 5 mA)
- Low capacitance (typ. 0.5 pF @ 0V)
- Fast switching applications
- Pb-free (RoHS compliant) package¹⁾
- Qualified according AEC Q101

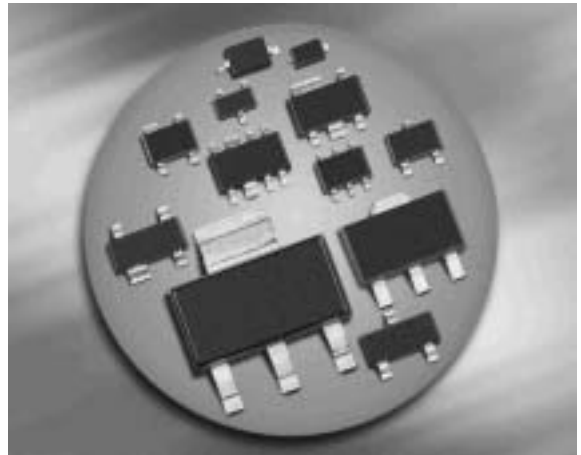

BAR65-02L
BAR65-02V
BAR65-03W

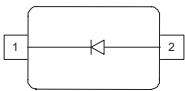

Type	Package	Configuration	L_S (nH)	Marking
BAR65-02L*	TSLP-2-1	single, leadless	0.4	NN
BAR65-02V	SC79	single	0.6	N
BAR65-03W	SOD323	single	1.8	M/blue

* Preliminary Data

Maximum Ratings at $T_A = 25^\circ\text{C}$, unless otherwise specified

Parameter	Symbol	Value	Unit
Diode reverse voltage	V_R	30	V
Forward current	I_F	100	mA
Total power dissipation	P_{tot}		mW
BAR65-02L, $T_S \leq 128^\circ\text{C}$		250	
BAR65-02V, $T_S \leq 118^\circ\text{C}$		250	
BAR65-03W, $T_S \leq 113^\circ\text{C}$		250	
Junction temperature	T_j	150	$^\circ\text{C}$
Operating temperature range	T_{op}	-55 ... 125	
Storage temperature	T_{stg}	-55 ... 150	

¹⁾Pb-containing package may be available upon special request

Thermal Resistance

Parameter	Symbol	Value	Unit
Junction - soldering point ¹⁾	R_{thJS}		K/W
BAR65-02L		≤ 90	
BAR65-02V		≤ 130	
BAR65-03W		≤ 145	

Electrical Characteristics at $T_A = 25^\circ\text{C}$, unless otherwise specified

Parameter	Symbol	Values			Unit
		min.	typ.	max.	

DC Characteristics

Reverse current $V_R = 20\text{ V}$	I_R	-	-	20	nA
Forward voltage $I_F = 100\text{ mA}$	V_F	-	0.93	1	V

¹⁾For calculation of R_{thJA} please refer to Application Note Thermal Resistance

Electrical Characteristics at $T_A = 25^\circ\text{C}$, unless otherwise specified

Parameter	Symbol	Values			Unit
		min.	typ.	max.	
AC Characteristics					
Diode capacitance $V_R = 1\text{ V}, f = 1\text{ MHz}$ $V_R = 3\text{ V}, f = 1\text{ MHz}$ $V_R = 0\text{ V}, f = 100\text{ MHz} \dots 1.8\text{ GHz}$	C_T	- - -	0.45 0.4 0.5	0.9 0.8 -	pF
Reverse parallel resistance $V_R = 0\text{ V}, f = 100\text{ MHz}$ $V_R = 0\text{ V}, f = 1\text{ GHz}$ $V_R = 0\text{ V}, f = 1.8\text{ GHz}$	R_P	- - -	700 10 5	- - -	k Ω
Forward resistance $I_F = 1\text{ mA}, f = 100\text{ MHz}$ $I_F = 5\text{ mA}, f = 100\text{ MHz}$ $I_F = 10\text{ mA}, f = 100\text{ MHz}$	r_f	- - -	1 0.65 0.56	- 0.95 0.9	Ω
Charge carrier life time $I_F = 10\text{ mA}, I_R = 6\text{ mA}$, measured at $I_R = 3\text{ mA}$, $R_L = 100\ \Omega$	τ_{rr}	-	80	-	ns
I-region width	W_I	-	3.5	-	μm
Insertion loss ¹⁾ $I_F = 1\text{ mA}, f = 1.8\text{ GHz}$ $I_F = 5\text{ mA}, f = 1.8\text{ GHz}$ $I_F = 10\text{ mA}, f = 1.8\text{ GHz}$	I_L	- - -	0.08 0.06 0.05	- - -	dB
Isolation ¹⁾ $V_R = 0\text{ V}, f = 0.9\text{ GHz}$ $V_R = 0\text{ V}, f = 1.8\text{ GHz}$ $V_R = 0\text{ V}, f = 2.45\text{ GHz}$	I_{SO}	- - -	12 7 5	- - -	

¹BAR65-02L in series configuration, $Z = 50\ \Omega$

Diode capacitance $C_T = f(V_R)$

$f = \text{Parameter}$

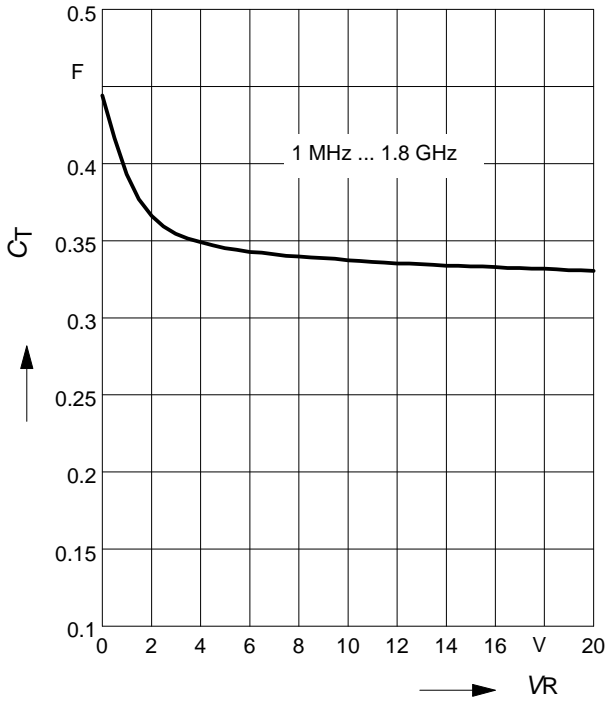

Reverse parallel resistance $R_p = f(V_R)$

$f = \text{Parameter}$

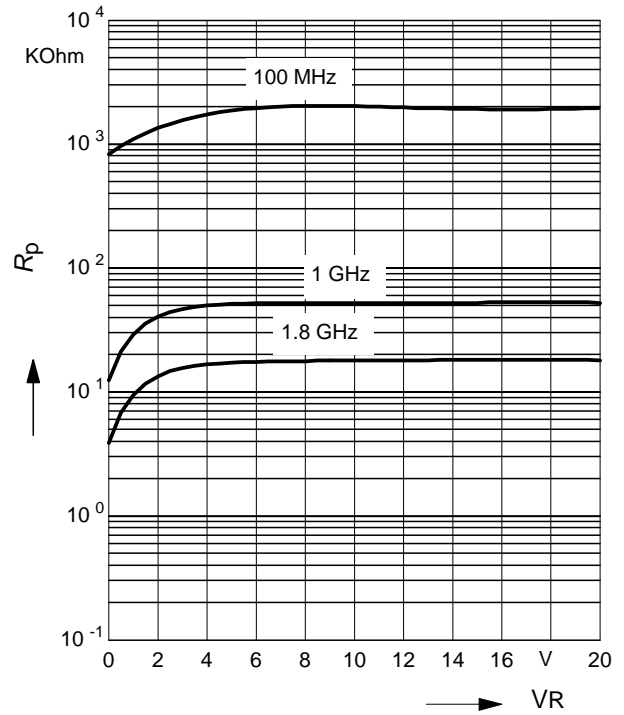

Forward resistance $r_f = f(I_F)$

$f = 100\text{MHz}$

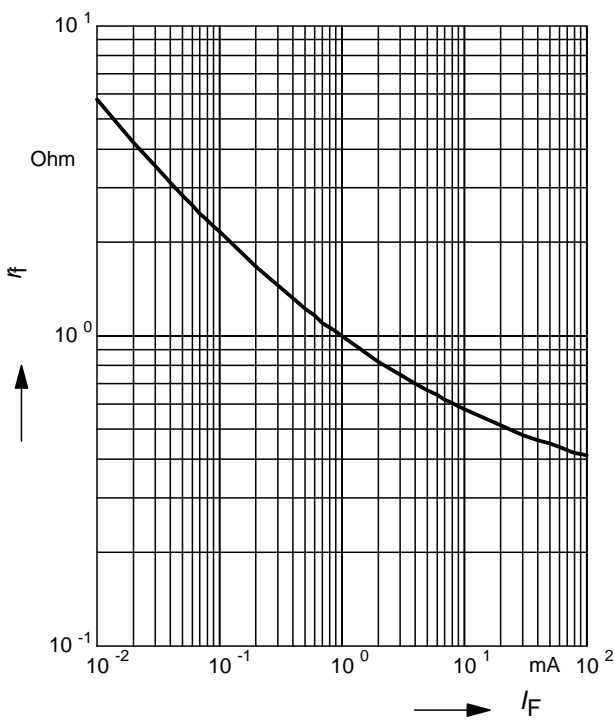

Forward current $I_F = f(V_F)$

$T_A = \text{Parameter}$

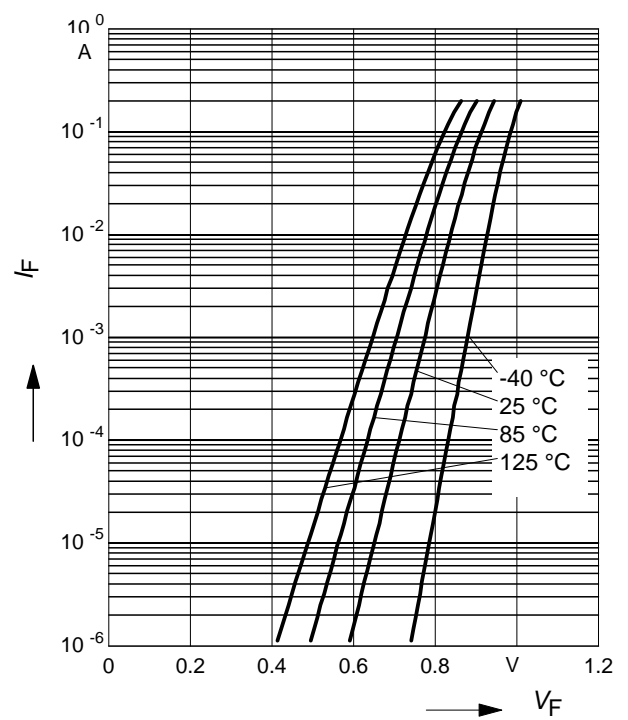

Forward current $I_F = f(T_S)$

BAR65-02L

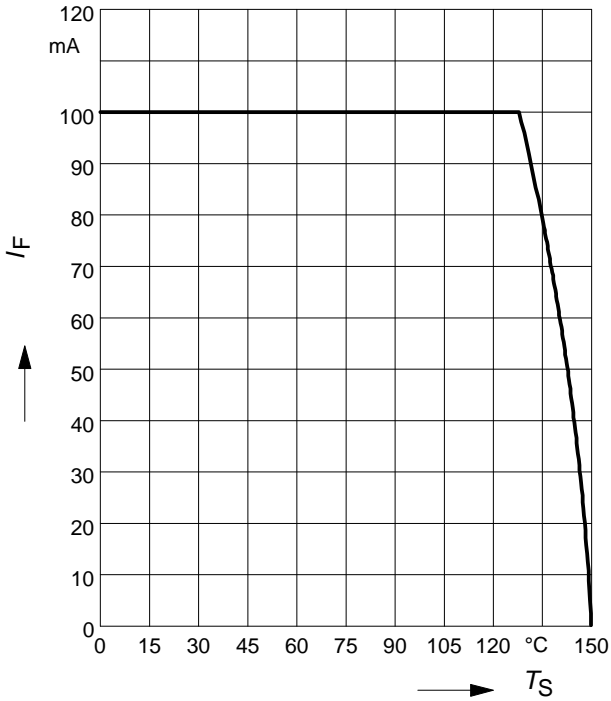

Forward current $I_F = f(T_S)$

BAR65-02V

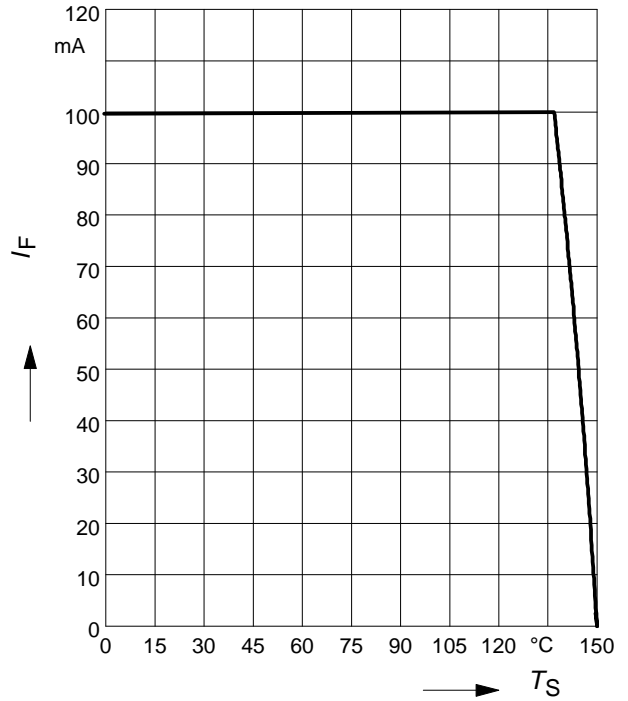

Forward current $I_F = f(T_S)$

BAR65-03W

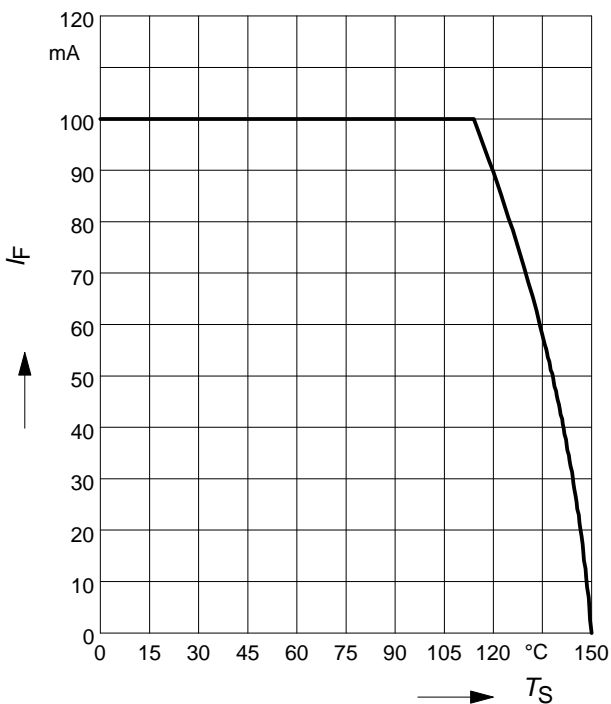

Permissible Puls Load $R_{thJS} = f(t_p)$

BAR65-02L

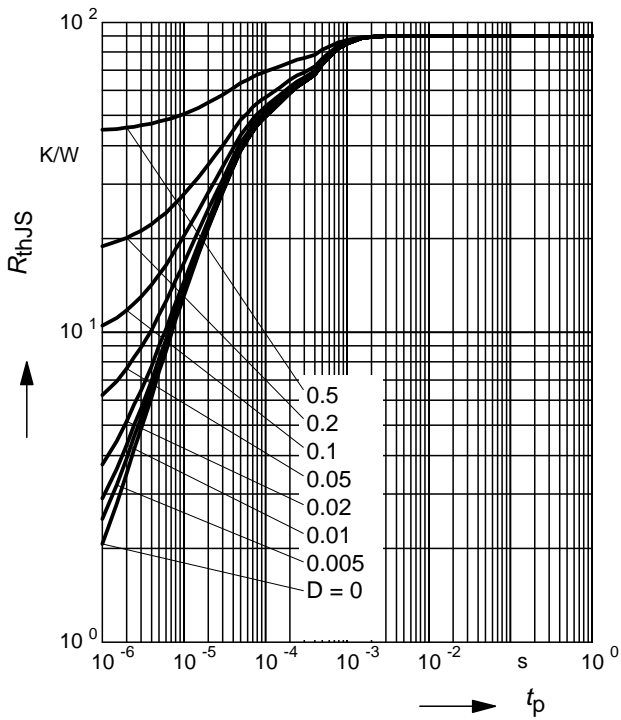

Permissible Pulse Load

$I_{Fmax} / I_{FDC} = f(t_p)$

BAR65-02L

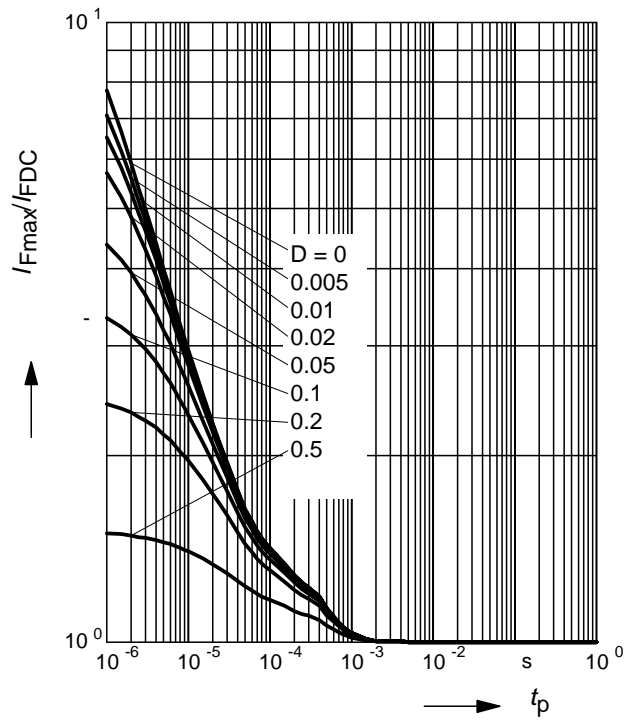

Permissible Puls Load $R_{thJS} = f(t_p)$

BAR65-02V

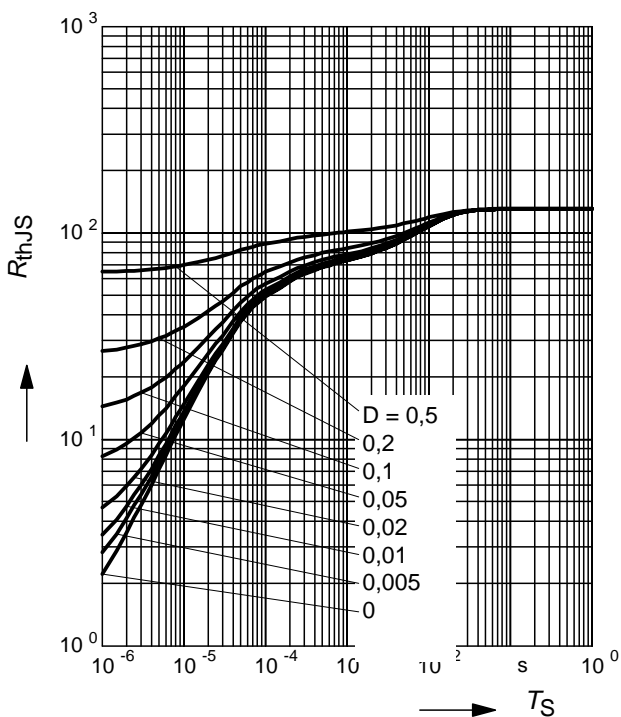

Permissible Pulse Load

$I_{Fmax} / I_{FDC} = f(t_p)$

BAR65-02V

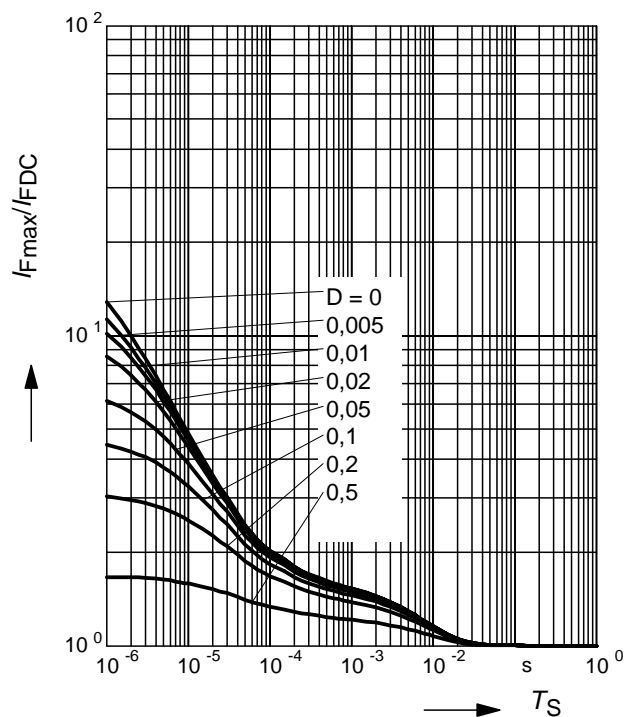

Permissible Puls Load $R_{thJS} = f(t_p)$

BAR65-03W

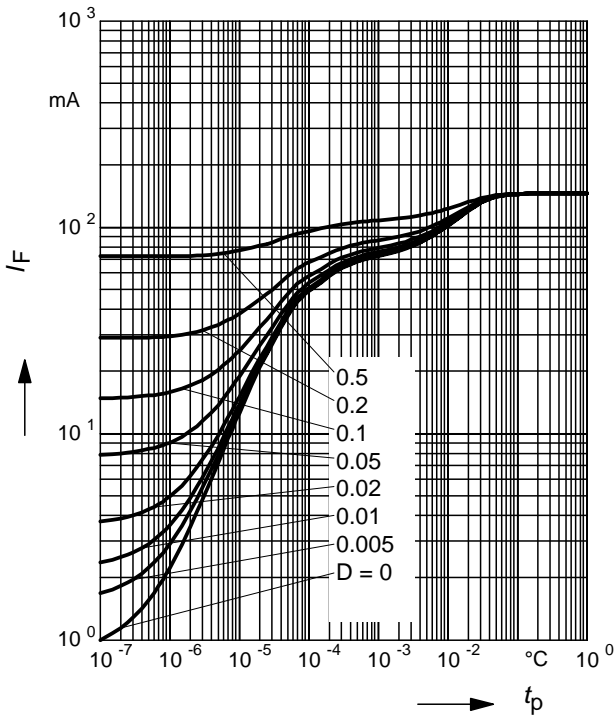

Permissible Pulse Load

$I_{Fmax} / I_{FDC} = f(t_p)$

BAR65-03W

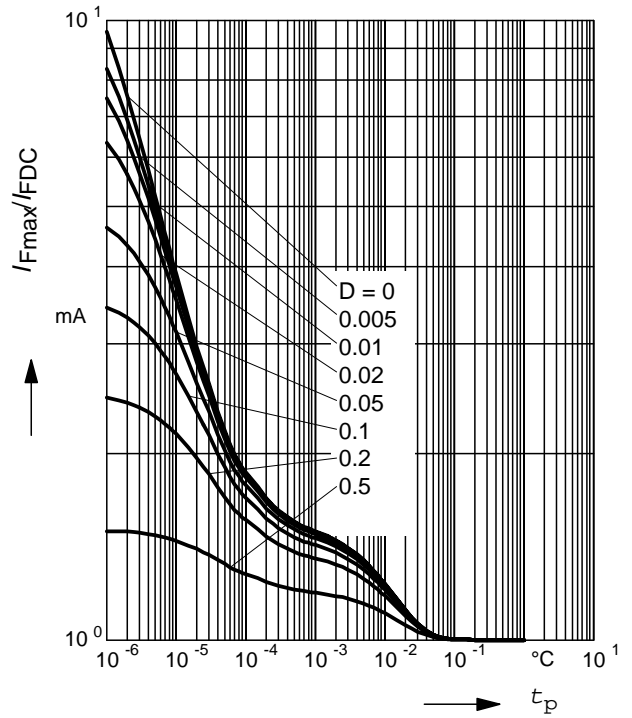

Insertion loss $I_L = -|S_{21}|^2 = f(f)$

I_F = Parameter

BAR65-02L in series configuration, $Z = 50\Omega$

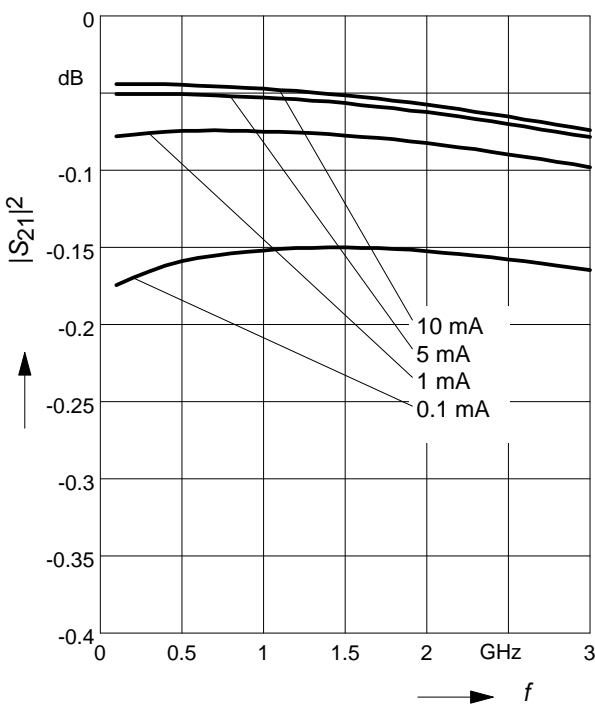

Isolation $I_{SO} = -|S_{21}|^2 = f(f)$

V_R = Parameter

BAR65-02L in series configuration $Z = 50\Omega$

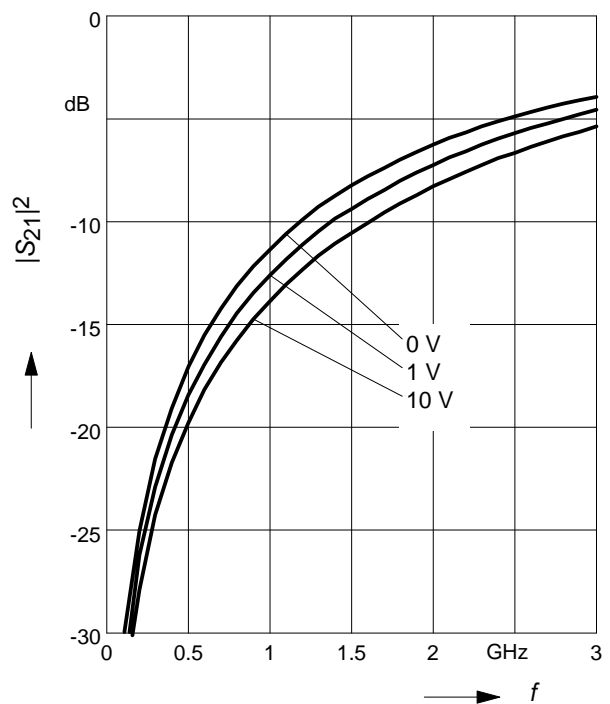

Package Outline

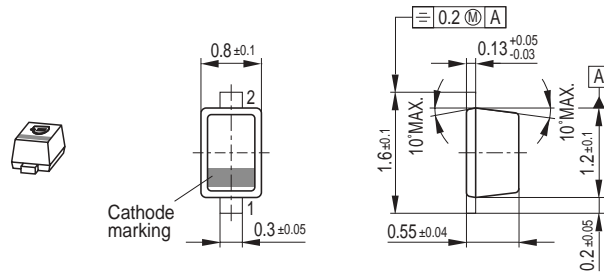

Foot Print

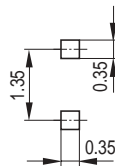

Marking Layout (Example)

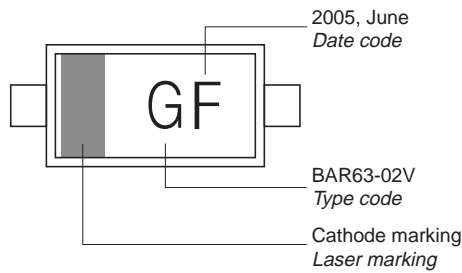

Standard Packing

Reel \varnothing 180 mm = 3.000 Pieces/Reel
 Reel \varnothing 180 mm = 8.000 Pieces/Reel (2 mm Pitch)
 Reel \varnothing 330 mm = 10.000 Pieces/Reel

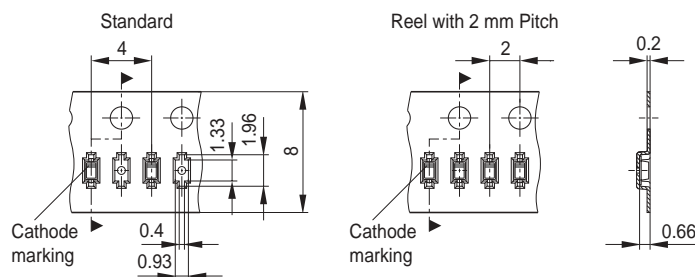

Date Code marking for discrete packages with one digit (SCD80, SC79, SC75¹⁾) CES-Code

Month	2003	2004	2005	2006	2007	2008	2009	2010	2011	2012	2013	2014
01	a	p	A	P	a	p	A	P	a	p	A	P
02	b	q	B	Q	b	q	B	Q	b	q	B	Q
03	c	r	C	R	c	r	C	R	c	r	C	R
04	d	s	D	S	d	s	D	S	d	s	D	S
05	e	t	E	T	e	t	E	T	e	t	E	T
06	f	u	F	U	f	u	F	U	f	u	F	U
07	g	v	G	V	g	v	G	V	g	v	G	V
08	h	x	H	X	h	x	H	X	h	x	H	X
09	j	y	J	Y	j	y	J	Y	j	y	J	Y
10	k	z	K	Z	k	z	K	Z	k	z	K	Z
11	l	2	L	4	l	2	L	4	l	2	L	4
12	n	3	N	5	n	3	N	5	n	3	N	5

1) New Marking Layout for SC75, implemented at October 2005.

Package Outline

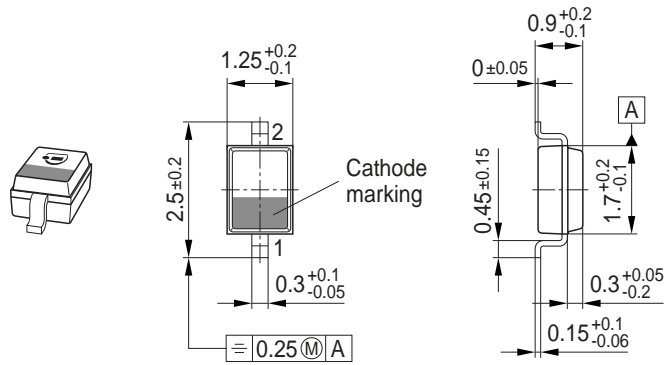

Foot Print

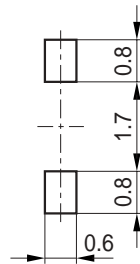

Marking Layout (Example)

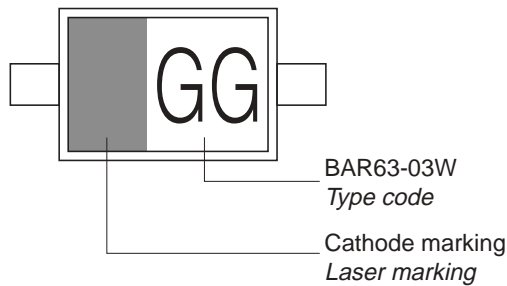

Standard Packing

Reel \varnothing 180 mm = 3.000 Pieces/Reel
 Reel \varnothing 330 mm = 10.000 Pieces/Reel

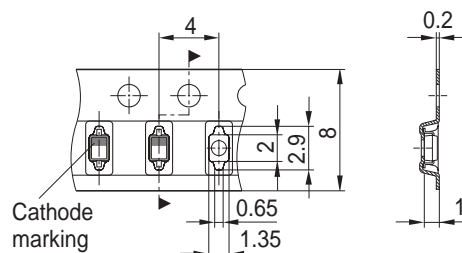

Package Outline

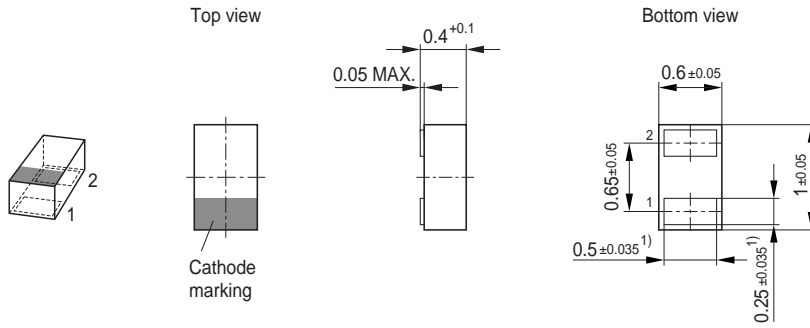

1) Dimension applies to plated terminal

Foot Print

For board assembly information please refer to Infineon website "Packages"

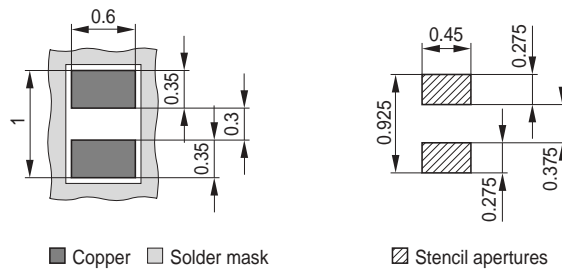

Marking Layout (Example)

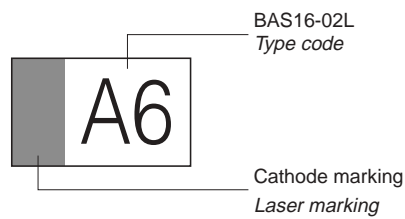

Standard Packing

Reel \varnothing 180 mm = 15.000 Pieces/Reel
 Reel \varnothing 330 mm = 50.000 Pieces/Reel (optional)

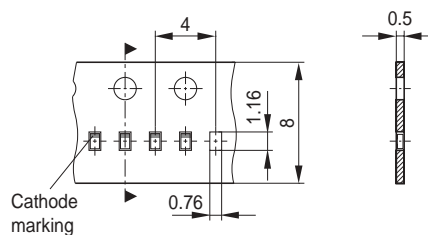

Edition 2006-02-01
Published by
Infineon Technologies AG
81726 München, Germany
© Infineon Technologies AG 2007.
All Rights Reserved.

Attention please!

The information given in this dokument shall in no event be regarded as a guarantee of conditions or characteristics ("Beschaffenheitsgarantie"). With respect to any examples or hints given herein, any typical values stated herein and/or any information regarding the application of the device, Infineon Technologies hereby disclaims any and all warranties and liabilities of any kind, including without limitation warranties of non-infringement of intellectual property rights of any third party.

Information

For further information on technology, delivery terms and conditions and prices please contact your nearest Infineon Technologies Office (www.infineon.com).

Warnings

Due to technical requirements components may contain dangerous substances. For information on the types in question please contact your nearest Infineon Technologies Office.

Infineon Technologies Components may only be used in life-support devices or systems with the express written approval of Infineon Technologies, if a failure of such components can reasonably be expected to cause the failure of that life-support device or system, or to affect the safety or effectiveness of that device or system.

Life support devices or systems are intended to be implanted in the human body, or to support and/or maintain and sustain and/or protect human life. If they fail, it is reasonable to assume that the health of the user or other persons may be endangered.